

## Product Summary (@T<sub>A</sub> = +25°C)

Name	V <sub>RRM</sub> (V)	I <sub>O</sub> (A)	V <sub>F</sub> Max (V)	I <sub>R</sub> Max (μA)
SD103AW	40	0.2	0.60	5.0μA@30V
SD103BW	30	0.2	0.60	5.0μA@20V
SD103CW	20	0.2	0.60	5.0μA@10V

## Description

These are 0.2A, 20V/30V/40V Schottky rectifier packaged in SOD123 package.

## Applications

Providing low V<sub>F</sub> and low reverse leakage, this device is ideal for use in general rectification applications such as:

- Low Voltage Rectification
- High-Efficiency DC-DC Conversion
- Switch Mode Power Supply
- Inverse Polarity Protection

## Features and Benefits

- Low Forward Voltage Drop (V<sub>F</sub>)
- Better Efficiency and Cooler Operation
- Guard Ring Construction for Transient Protection
- **Totally Lead-Free & Fully RoHS Compliant (Notes 1 & 2)**
- **Halogen and Antimony Free. "Green" Device (Note 3)**

## Mechanical Data

- Case: SOD123
- Case Material: Molded Plastic. UL Flammability Classification Rating 94V-0
- Moisture Sensitivity: Level 1 per J-STD-020
- Terminals: Matte Tin Finish Annealed over Alloy 42 Leadframe. Solderable per MIL-STD-202, Method 208
- Polarity: Cathode Band
- Weight: 0.01 grams (Approximate)

SOD123



Top View

## Ordering Information (Note 4)

Part Number	Case	Packaging
SD103AW-7-F	SOD123	3000/Tape and Reel
SD103BW-7-F	SOD123	3000/Tape and Reel
SD103CW-7-F	SOD123	3000/Tape and Reel
SD103CW-13-F	SOD123	10,000/Tape and Reel

- Notes:
1. No purposely added lead. Fully EU Directive 2002/95/EC (RoHS) & 2011/65/EU (RoHS 2) compliant.
  2. See [http://www.diodes.com/quality/lead\\_free.html](http://www.diodes.com/quality/lead_free.html) for more information about Diodes Incorporated's definitions of Halogen- and Antimony-free, "Green" and Lead-free.
  3. Halogen- and Antimony-free "Green" products are defined as those which contain <900ppm bromine, <900ppm chlorine (<1500ppm total Br + Cl) and <1000ppm antimony compounds.
  4. For packaging details, go to our website at <http://www.diodes.com/products/packages.html>.

## Maximum Ratings (@T<sub>A</sub> = +25°C, unless otherwise specified.)

Characteristic	Symbol	SD103AW	SD103BW	SD103CW	Unit
Peak Repetitive Reverse Voltage	V <sub>RRM</sub>				V
Working Peak Reverse Voltage	V <sub>RWM</sub>	40	30	20	V
DC Blocking Voltage	V <sub>R</sub>				V
RMS Reverse Voltage	V <sub>R(RMS)</sub>	28	21	14	V
Forward Continuous Current (Note 5)	I <sub>FM</sub>		350		mA
Non-Repetitive Peak Forward Surge Current @ t ≤ 1.0s	I <sub>FSM</sub>		1.5		A

### Thermal Characteristics

Characteristic	Symbol	Value	Unit
Power Dissipation (Note 5)	$P_D$	367	mW
Typical Thermal Resistance Junction to Ambient (Note 5)	$R_{\theta JA}$	340	$^{\circ}C/W$
Operating and Storage Temperature Range	$T_J, T_{STG}$	-55 to +150	$^{\circ}C$

### Electrical Characteristics (@ $T_A = +25^{\circ}C$ , unless otherwise specified.)

Characteristic	Symbol	Min	Typ	Max	Unit	Test Condition
Reverse Breakdown Voltage (Note 6)	$V_{(BR)R}$	40	—	—	V	$I_R = 100\mu A$
Forward Voltage Drop	$V_{FM}$	—	—	0.37 0.60	V	$I_F = 20mA$ $I_F = 200mA$
Peak Reverse Current (Note 6)	$I_{RM}$	—	—	5.0	$\mu A$	$V_R = 30V$ $V_R = 20V$ $V_R = 10V$
Total Capacitance	$C_T$	—	28	—	pF	$V_R = 0V, f = 1.0MHz$
Reverse Recovery Time	$t_{RR}$	—	10	—	ns	$I_F = I_R = 200mA,$ $I_{RR} = 0.1 \times I_R, R_L = 100\Omega$

Notes: 5. Part mounted on FR-4 board with recommended pad layout, which can be found on our website at <http://www.diodes.com/package-outlines.html>.  
6. Short duration test pulse used to minimize self-heating effect.

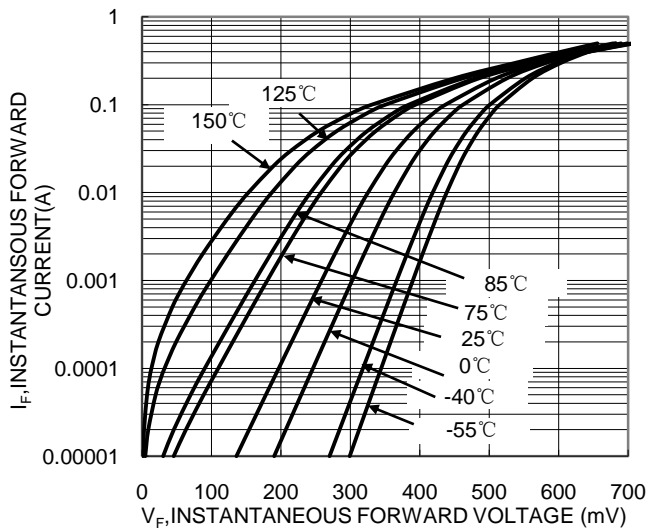

Fig. 1 Typical Forward Characteristics

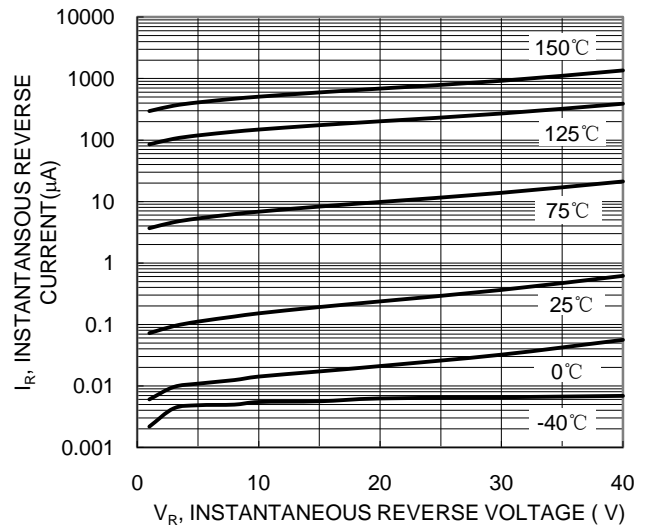

Fig. 2 Typical Reverse Characteristics

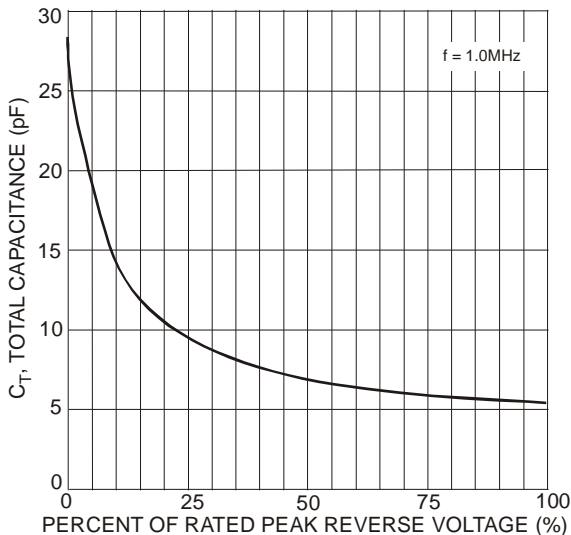

Fig. 3 Total Capacitance vs. Reverse Voltage

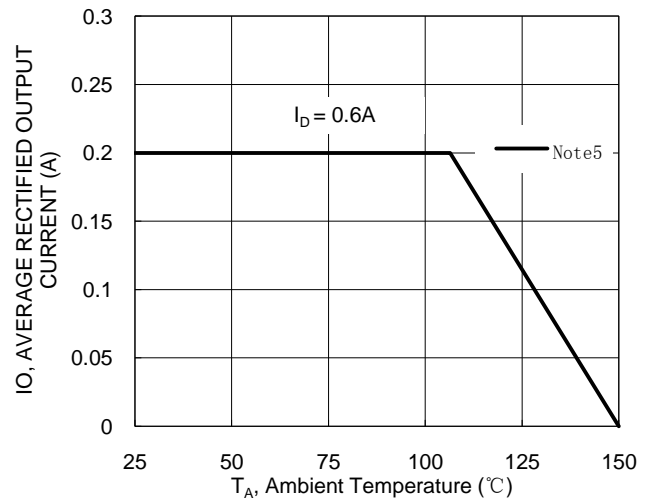
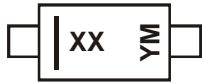
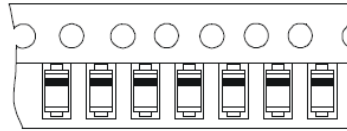

Fig. 4. DC Forward Current Derating

### Marking Information



XX= Product Type Marking Code  
 S4 = SD103AW  
 S5 or S4 = SD103BW  
 S6 or S5 or S4 = SD103CW  
 Y = Year (ex: D = 2016)  
 M = Month (ex: 9 = September)  
 Bar Denotes Cathode Pin



Year	2013	2014	2015	2016	2017	2018	2019	2020
Code	A	B	C	D	E	F	G	H

Month	Jan	Feb	Mar	Apr	May	Jun	Jul	Aug	Sep	Oct	Nov	Dec
Code	1	2	3	4	5	6	7	8	9	O	N	D

### Package Outline Dimensions

Please see <http://www.diodes.com/package-outlines.html> for the latest version.

SOD123

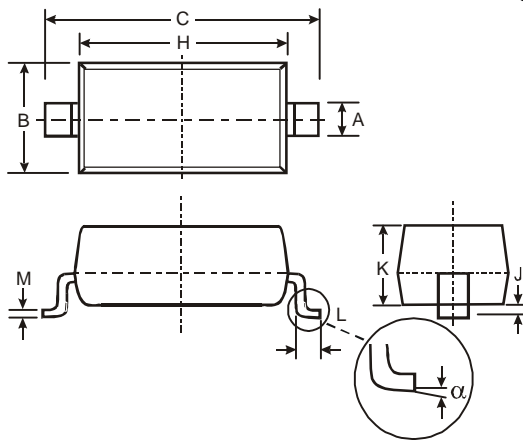

SOD123		
Dim	Min	Max
A	0.55 Typ	
B	1.40	1.70
C	3.55	3.85
H	2.55	2.85
J	0.00	0.10
K	1.00	1.35
L	0.25	0.40
M	0.10	0.15
$\alpha$	0	8°
All Dimensions in mm		

### Suggested Pad Layout

Please see <http://www.diodes.com/package-outlines.html> for the latest version.

SOD123

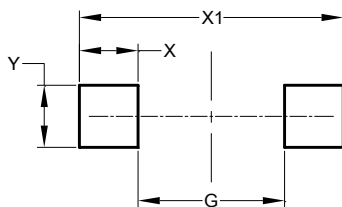

Dimensions	Value(in mm)
G	2.250
X	0.900
X1	4.050
Y	0.950

**IMPORTANT NOTICE**

DIODES INCORPORATED MAKES NO WARRANTY OF ANY KIND, EXPRESS OR IMPLIED, WITH REGARDS TO THIS DOCUMENT, INCLUDING, BUT NOT LIMITED TO, THE IMPLIED WARRANTIES OF MERCHANTABILITY AND FITNESS FOR A PARTICULAR PURPOSE (AND THEIR EQUIVALENTS UNDER THE LAWS OF ANY JURISDICTION).

Diodes Incorporated and its subsidiaries reserve the right to make modifications, enhancements, improvements, corrections or other changes without further notice to this document and any product described herein. Diodes Incorporated does not assume any liability arising out of the application or use of this document or any product described herein; neither does Diodes Incorporated convey any license under its patent or trademark rights, nor the rights of others. Any Customer or user of this document or products described herein in such applications shall assume all risks of such use and will agree to hold Diodes Incorporated and all the companies whose products are represented on Diodes Incorporated website, harmless against all damages.

Diodes Incorporated does not warrant or accept any liability whatsoever in respect of any products purchased through unauthorized sales channel. Should Customers purchase or use Diodes Incorporated products for any unintended or unauthorized application, Customers shall indemnify and hold Diodes Incorporated and its representatives harmless against all claims, damages, expenses, and attorney fees arising out of, directly or indirectly, any claim of personal injury or death associated with such unintended or unauthorized application.

Products described herein may be covered by one or more United States, international or foreign patents pending. Product names and markings noted herein may also be covered by one or more United States, international or foreign trademarks.

This document is written in English but may be translated into multiple languages for reference. Only the English version of this document is the final and determinative format released by Diodes Incorporated.

**LIFE SUPPORT**

Diodes Incorporated products are specifically not authorized for use as critical components in life support devices or systems without the express written approval of the Chief Executive Officer of Diodes Incorporated. As used herein:

A. Life support devices or systems are devices or systems which:

1. are intended to implant into the body, or
2. support or sustain life and whose failure to perform when properly used in accordance with instructions for use provided in the labeling can be reasonably expected to result in significant injury to the user.

B. A critical component is any component in a life support device or system whose failure to perform can be reasonably expected to cause the failure of the life support device or to affect its safety or effectiveness.

Customers represent that they have all necessary expertise in the safety and regulatory ramifications of their life support devices or systems, and acknowledge and agree that they are solely responsible for all legal, regulatory and safety-related requirements concerning their products and any use of Diodes Incorporated products in such safety-critical, life support devices or systems, notwithstanding any devices- or systems-related information or support that may be provided by Diodes Incorporated. Further, Customers must fully indemnify Diodes Incorporated and its representatives against any damages arising out of the use of Diodes Incorporated products in such safety-critical, life support devices or systems.

Copyright © 2016, Diodes Incorporated

[www.diodes.com](http://www.diodes.com)